

flos

FS K 4R

: product card



The Flos collection is all about extremely comfortable seating with a wide range of bases: metal, wooden, on castors, low, high and benches. It is perfect for both office and home workplaces.

design:
Tomasz Augustyniak

**must
have**
THE BEST DESIGNER PRODUCTS

bejot:

Product website
[website link](#)



collection advantages

one chair - many possibilities

The Flos chair collection is distinguished by its wide range of bases (metal, wooden as well as on castors). Two equally comfortable seat types, with or without armrests, respond to the needs of today's working environment (office and home office).

user comfort

Flos seats use compression cones, which significantly increases seating comfort

technical data

FS K 4R

Standard ●
Option ○

Mechanism	CODE	
Rotatable, without height adjustment	A1	●
Rotable mechanism with 3d motion function (forward, backward and sideways) without height adjustment	O4	○
Base		
Polished aluminium 4-star base (chrome effect) Ø700	38	●
Powder coated aluminium 4-star base (colors according to Bejot sampler book) Ø700	39	○
Feet		
Feet on ceramic, concrete and carpet floors	TK	●
Felt feet on wooden floors and panels	TF	○

dimensions

FS K 4R

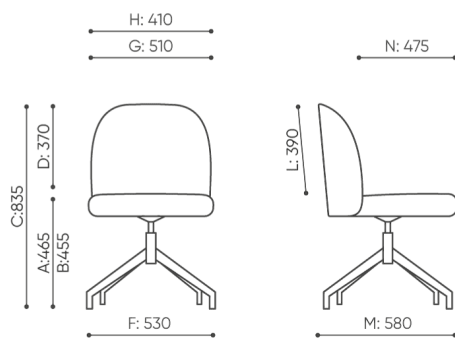

B seat height: measured according to the norm PN EN 1335-1 with a load of 640N	F dimensional width chair / base	K height from the floor to the armrest
C chair height adjustment	G seat width	L backrest length
D backrest height adjustment	H backrest width	M dimensional chair depth
		N seat depth adjustment / seat length

All dimensions are in [mm] and refer to basic version products. The indicated dimensions can change depending on the selected equipment package. Bejot reserves the right to change selected elements and this may slightly affect the product's dimensions. In case of any special requirements on dimensions of a given product, the afore-mentioned information should be acknowledged by the Producer. The specification does not constitute an offer within the meaning of the Civil Code. Dimensions and weights are approximate and may vary by 5%. The requirements of the standard are always met.

materials available for collection

1st price group	Fenno, Keimo, Lodge
2nd price group	Alaska, Alpa, Charles, Charles - Studio Design, Cura, Pastel, Roccia
3rd price group	Ally, Ally-Studio Design, Alpa-Studio Design, Blazer, Cura - Studio Design, Cyber-Studio Design, Easy - Studio Design, Oceanic, Silvertex , Silvertex - Studio Design, Synergy, Synergy - Studio Design
4th price group	Oceanic-Studio Design, Remix - Studio Design
5th price group	Steelcut Trio 3-Studio Design
Leather	Leather
Wood	Solid oak wood - clear varnish matt
Metal	Metal - powder coated

bejot:flos

