

# hens

HS 220 H

: product card



The hens collection is characterised by Scandinavian design and functionality. It adheres to the principles of simplicity, usability and naturalness. The strong steel frame gives the chairs a loft character. Their raw form is balanced by the natural oak veneer and soft upholstery.

**design:**  
**Henrik Schultz**

**Product website**  
[website link](#)



# bejot:

# collection advantages

## scandinavian design and functionality

The collection is a contemporary interpretation of the classic school chair. Designed with inspiration from Scandinavian design, it meets the objectives of simplicity, functionality and naturalness.

## easy stacking

The chairs are perfectly stackable, and some models can be joined together with a dedicated rail. This makes them suitable for virtually anywhere - from offices to schools and public spaces.

## practical armrests

The round cover (PUT) on the armrests is not only an aesthetic finish but also a functional solution that allows for the safe suspension of chairs on the table top. This facilitates keeping floors clean in conference rooms, canteens, and other spaces.

## technical data

HS 220 H

Standard ●  
Option ○

### Base

Powder painted (colors according to the Bejot pattern book) ●

### Colors for the 1N/2N version

Natural veneer - clear varnish matt ONB ●

1N - backrest and seat - natural veneer, varnish according to the Bejot sampler ○

2N - backrest - natural veneer, varnish according to the Bejot sampler ○

### Armpads

Soft, black polyurethane - PU ●

### Writing pad

Mobile writing pad made of black plastic - right PR ○

Mobile writing pad made of black plastic - left EN ○

### Additional equipment

Black masking panel that protects the chairs from scratches during stacking CP ●

### Feet

Feet on ceramic, concrete and carpet floors TK ●

Felt feet on wooden floors and panels TF ○

**Description****Code**

Seat and backrest, natural oak veneer

1N

Upholstered seat / backrest, natural oak veneer

2N

Upholstered seat and backrest

4N

**Stacking**

HS 220P H 1N

4 psc.

HS 220P H 2N

4 psc.

HS 220P H 4N

4 psc.



stacking

# dimensions

## HS 220 H

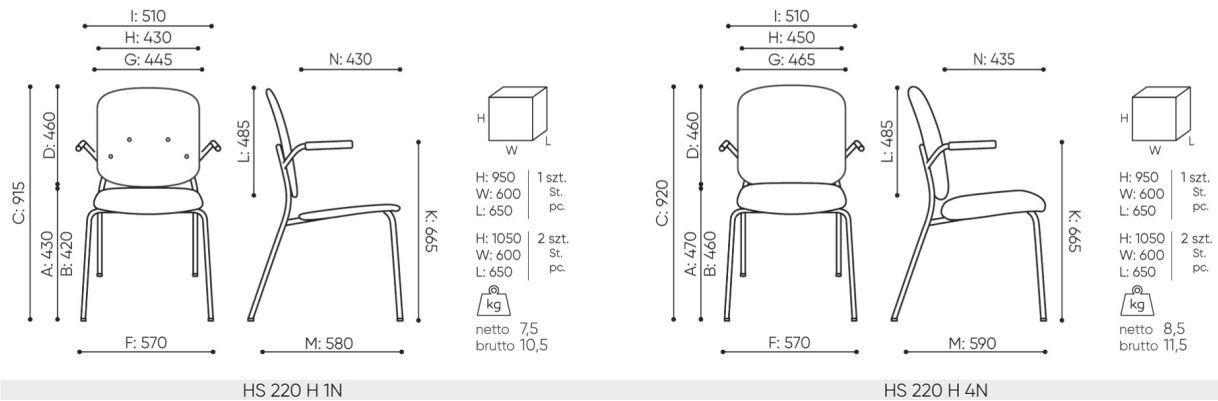

- B** seat height: measured according to the norm PN EN 1335-1 with a load of 640N
- C** chair height adjustment
- D** backrest height adjustment
- F** dimensional width chair / base
- G** seat width
- H** backrest width
- K** height from the floor to the armrest
- L** backrest length
- M** dimensional chair depth
- N** seat depth adjustment / seat length

All dimensions are in [mm] and refer to basic version products. The indicated dimensions can change depending on the selected equipment package. Bejot reserves the right to change selected elements and this may slightly affect the product's dimensions. In case of any special requirements on dimensions of a given product, the afore-mentioned information should be acknowledged by the Producer. The specification does not constitute an offer within the meaning of the Civil Code. Dimensions and weights are approximate and may vary by 5%. The requirements of the standard are always met.

## materials available for collection

1st price group	Bond, Fenno, Keimo, Lodge, Sawana
2nd price group	Alaska, Alpa, Charles, Charles - Studio Design, Cura, Era - Studio Design, Pastel, Roccia
3rd price group	Ally, Ally-Studio Design, Alpa-Studio Design, Blazer, Cura - Studio Design, Cyber-Studio Design, Easy - Studio Design, Oceanic, Rhythm, Silvertex , Silvertex - Studio Design, Synergy, Synergy - Studio Design
4th price group	Oceanic-Studio Design, Remix - Studio Design
5th price group	Steelcut Trio 3-Studio Design
Leather	Leather
Natural oak veneer	Natural oak veneer
Metal	Metal - powder coated

bejot:hens

