

OX:CO

OX 270

: product card



A recognisable collection that has become a permanent fixture in many interiors. The eye-catching design of this armchair perfectly emphasises the minimalist yet intriguing form of the seat. Thanks to the unique combination of various materials, the simplicity of the bucket construction acquires a distinctive character.

design:
Włodzimierz Orsztynowicz

Product website
[website link](#)



bejot:

collection advantages

Simple, but not banal

As it frequently happens, the simplest solutions are the best, but simple does not mean banal. Therefore, you cannot remain indifferent to the Ox:co design. Thanks to the use of the original combination of the materials, the simple but interesting form of the bucket was emphasised.

Nonconformist design

A non-conformist, eye-catching design of this armchair cleanses the atmosphere from boredom. It will add character to any interior, and you will provide the highest standard of convenience, no matter where it finds its place.

technical data

OX 270

Standard ●
Option ○

Base

- Powder painted rod base (colors according to the Bejot sampler book) ●
- Chromed rod base ○

Glides

- Glides for ceramic floors, concrete and carpets PK ●
- Felt glides for wooden floors and floor panels PF ○

Upholstery

- Possibility of upholstery in 3 different colors within 1 fabric ○

dimensions

OX 270

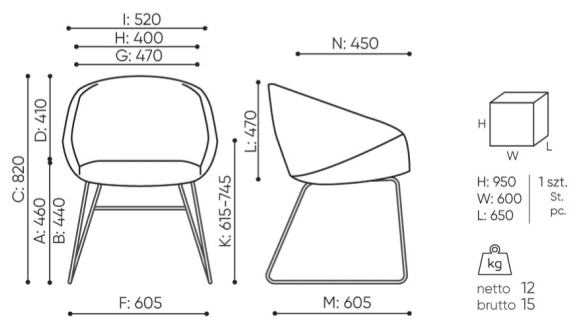

OX 270

- A seat height: overall dimensions
- B seat height: measured according to the norm
PN EN 1335 - 1
- C chair height
- D backrest height
- E headrest height
- F dimensional width chair / base
- G seat width
- H backrest width
- I width between armrests
- K height from the floor to the armrest
- L backrest length
- M dimensional chair depth
- N seat depth / seat length

Dimensions are approximate and may vary depending on the selected product configuration. The requirements of the standard are always met.

materials available for collection

1st price group	Bond, Fenno, Keimo, Sawana
2nd price group	Alpa, Charles, Charles - Studio Design, Cura, Pastel, Roccia, Valencia
3rd price group	Ally, Ally SD, Alpa-Studio Design, Blazer, Cura SD, Easy SD, Oceanic, Silvertex , Silvertex - Studio Design, Synergy, Synergy - Studio Design, Valencia - Studio Design
4th price group	Heritage, Oceanic-Studio Design, Remix - Studio Design
5th price group	Accessoire, Steelcut Trio 3
Leather	Leather
Wood	Solid oak wood
Metal	Metal - powder coated, Metal ALU/chrom

bejot:ox:co

