



## spin SN W HB1

### Seduces with simplicity

We want to be seduced by simplicity, but at the same time we want objects that surround us to be deeply thought out and technologically advanced. The answer to this is the practical and thrilling Spin collection.

### The most important is the detail

Spin is the proof that everything revolves around a well-designed detail. A detail that not only makes the product visually unique, but also raises comfort to a higher level.

## SN W HB1 / Technical data

Standard

Option

### Base

Legs: solid oak wood - natural color (O1) + powder coated metal construction (colors according to the Bejot sampler)

Legs: solid wood - black coloring (O3) + powder coated metal construction (colors according to the Bejot sampler)

Footstool (ring) brushed chromium-nickel steel

Height adjustment screw

A backrest made of plywood colored according to the Bejot sampler (an upholstered front of the backrest), a metal connector, powder coated in the color of the construction

A backrest fully upholstered - suggested when choosing oak solid wood legs, a metal connector, powder coated in the color of the structure

### Feet

#### CODE

Felt feet for wooden floors and panels

WF

Feet for ceramic floors, concrete & carpets

WK

### Stitches

#### CODE

Stitches in the colour of upholstery

White, grey, orange, red, green or black stitches

## SN W HB1 / Dimensions

Dimensions are approximate and may vary depending on the selected product configuration. The requirements of the standard are always met.

seat height: overall dimensions	A
seat height: measured according to the norm PN EN 1335 - 1	B
chair height	C
backrest height	D
headrest height	E
dimensional width chair / ø base	F
seat width	G
backrest width	H
width between armrests	I
height from the floor to the armrest	K
backrest length	L
dimensional chair depth	M
seat depth / seat length	N

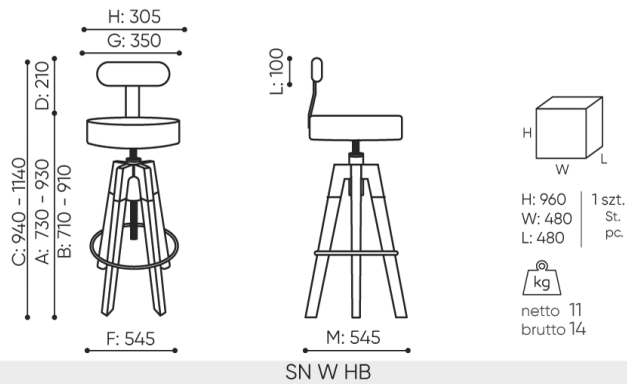



## spin SN W H

### Seduces with simplicity

We want to be seduced by simplicity, but at the same time we want objects that surround us to be deeply thought out and technologically advanced. The answer to this is the practical and thrilling Spin collection.

### The most important is the detail

Spin is the proof that everything revolves around a well-designed detail. A detail that not only makes the product visually unique, but also raises comfort to a higher level.

## SN W H / Technical data

● Standard

○ Option

### Base

Legs: solid oak wood - natural color (O1) + powder coated metal construction (colors according to the Bejot sampler) ●

Legs: solid wood - black coloring (O3) + powder coated metal construction (colors according to the Bejot sampler) ○

Footstool (ring) brushed chromium-nickel steel ●

Height adjustment screw ●

### Feet

#### CODE

Felt feet on wooden floors and panels ●

WF

Feet on ceramic, concrete and carpet floors ○

WK

### Stitches

#### CODE

Stitches in the colour of upholstery. ●

White, grey, orange, red, green or black stitches. ○

## SN W H / Dimensions

Dimensions are approximate and may vary depending on the selected product configuration. The requirements of the standard are always met.

seat height: overall dimensions	A
seat height: measured according to the norm PN EN 1335 - 1	B
chair height	C
backrest height	D
headrest height	E
dimensional width chair / ø base	F
seat width	G
backrest width	H
width between armrests	I
height from the floor to the armrest	K
backrest length	L
dimensional chair depth	M
seat depth / seat length	N

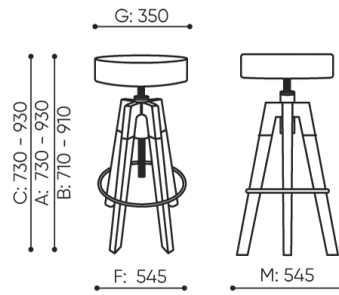

H: 770  
W: 480  
L: 480

1 szt.  
St.  
pc.



netto 9  
brutto 12

SN W H

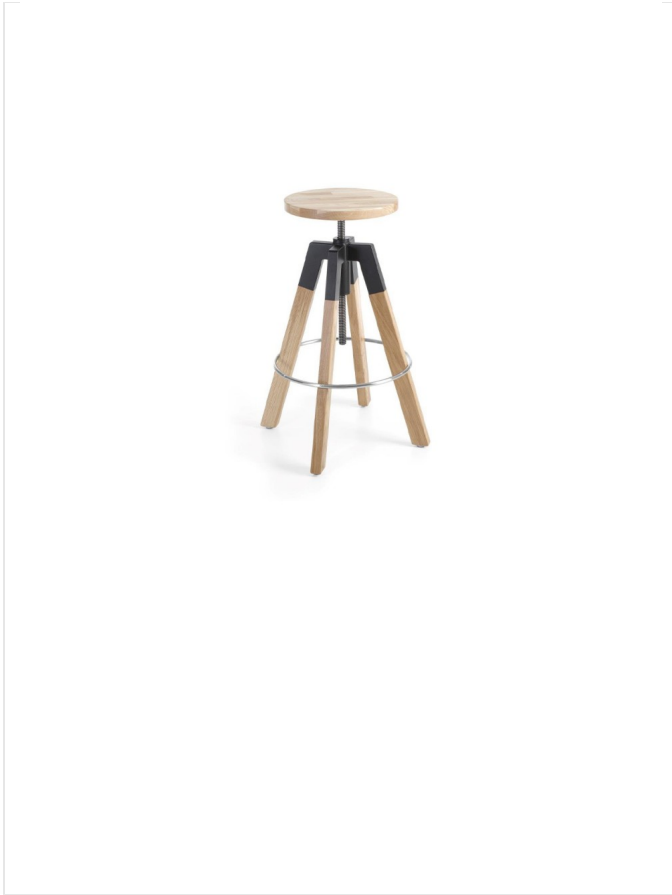

## spin SN W OH

### Seduces with simplicity

We want to be seduced by simplicity, but at the same time we want objects that surround us to be deeply thought out and technologically advanced. The answer to this is the practical and thrilling Spin collection.

### The most important is the detail

Spin is the proof that everything revolves around a well-designed detail. A detail that not only makes the product visually unique, but also raises comfort to a higher level.

## SN W OH / Technical data

● Standard

○ Option

### Base

Legs: solid oak wood - natural color (O1) + powder coated metal construction (colors according to the Bejot sampler) ●

Legs: solid wood - black coloring (O3) + powder coated metal construction (colors according to the Bejot sampler) ○

Footstool (ring) brushed chromium-nickel steel ●

Height adjustment screw ●

### Feet

### CODE

Felt feet on wooden floors and panels ●

WF

Feet on ceramic, concrete and carpet floors ○

WK

## SN W OH / Dimensions

Dimensions are approximate and may vary depending on the selected product configuration. The requirements of the standard are always met.

seat height: overall dimensions	A
seat height: measured according to the norm PN EN 1335 - 1	B
chair height	C
backrest height	D
headrest height	E
dimensional width chair / ø base	F
seat width	G
backrest width	H
width between armrests	I
height from the floor to the armrest	K
backrest length	L
dimensional chair depth	M
seat depth / seat length	N

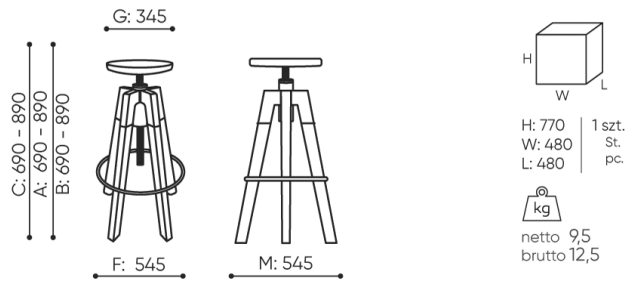

SN W OH



## spin SNR H

### Seduces with simplicity

We want to be seduced by simplicity, but at the same time we want objects that surround us to be deeply thought out and technologically advanced. The answer to this is the practical and thrilling Spin collection.

### The most important is the detail

Spin is the proof that everything revolves around a well-designed detail. A detail that not only makes the product visually unique, but also raises comfort to a higher level.

## SNR H / Technical data

Standard

Option

### Base

Powder painted (colors according to the Bejot sampler book)

Height adjustment screw

### Feet

CODE

Spherical feet

### Stitches

CODE

Stitches in the colour of upholstery

White, grey, orange, red, green or black stitches

## SNR H / Dimensions

Dimensions are approximate and may vary depending on the selected product configuration. The requirements of the standard are always met.

seat height: overall dimensions	A
seat height: measured according to the norm PN EN 1335 - 1	B
chair height	C
backrest height	D
headrest height	E
dimensional width chair / ø base	F
seat width	G
backrest width	H
width between armrests	I
height from the floor to the armrest	K
backrest length	L
dimensional chair depth	M
seat depth / seat length	N

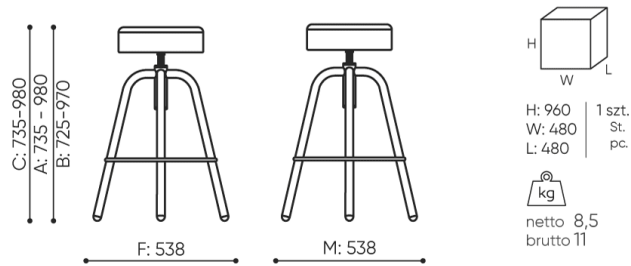

SNR H



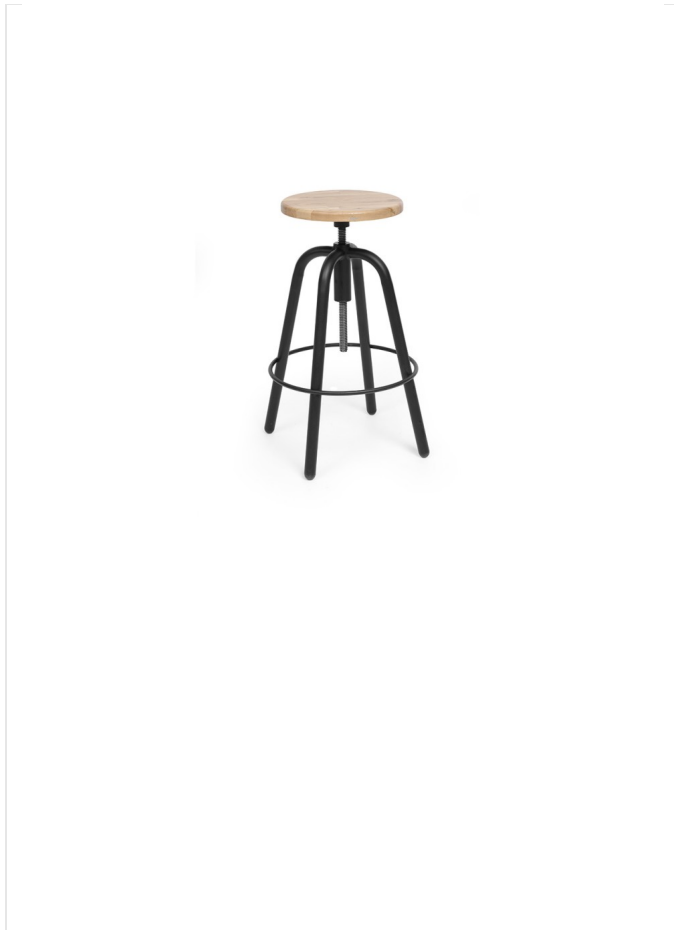

## spin SNR OH

### Seduces with simplicity

We want to be seduced by simplicity, but at the same time we want objects that surround us to be deeply thought out and technologically advanced. The answer to this is the practical and thrilling Spin collection.

### The most important is the detail

Spin is the proof that everything revolves around a well-designed detail. A detail that not only makes the product visually unique, but also raises comfort to a higher level.

## SNR OH / Technical data

Standard

Option

### Base

Powder painted (colors according to the Bejot sampler book)

Height adjustment screw

### Feet

### CODE

Spherical feet

## SNR OH / Dimensions

Dimensions are approximate and may vary depending on the selected product configuration. The requirements of the standard are always met.

seat height: overall dimensions	A
seat height: measured according to the norm PN EN 1335 - 1	B
chair height	C
backrest height	D
headrest height	E
dimensional width chair / ø base	F
seat width	G
backrest width	H
width between armrests	I
height from the floor to the armrest	K
backrest length	L
dimensional chair depth	M
seat depth / seat length	N

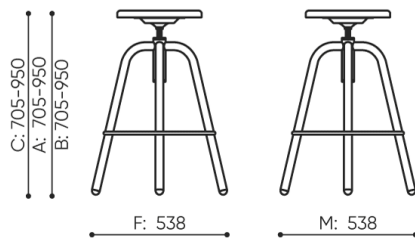

H: 960  
W: 480  
L: 480

1 szt.  
St.  
pc.



netto 19  
brutto 12

SNR OH

spin **SNR OTH**

**Seduces with simplicity**

We want to be seduced by simplicity, but at the same time we want objects that surround us to be deeply thought out and technologically advanced. The answer to this is the practical and thrilling Spin collection.

**The most important is the detail**

Spin is the proof that everything revolves around a well-designed detail. A detail that not only makes the product visually unique, but also raises comfort to a higher level.



**SNR OTH / Technical data**

Standard  Option

**Base**

- Powder painted (colors according to the Bejot sampler book)
- Height adjustment screw

**Feet**

**CODE**

- Spherical feet

**SNR OTH / Dimensions**

Dimensions are approximate and may vary depending on the selected product configuration. The requirements of the standard are always met.

seat height: overall dimensions	A
seat height: measured according to the norm PN EN 1335 - 1	B
chair height	C
backrest height	D
headrest height	E
dimensional width chair / ø base	F
seat width	G
backrest width	H
width between armrests	I
height from the floor to the armrest	K
backrest length	L
dimensional chair depth	M
seat depth / seat length	N

C: 475 - 675  
A: 475 - 675  
B: 475 - 675



H: 770  
W: 480  
L: 480

1 szt.  
St.  
pc.



netto 6,8  
brutto 9

SNR OTH

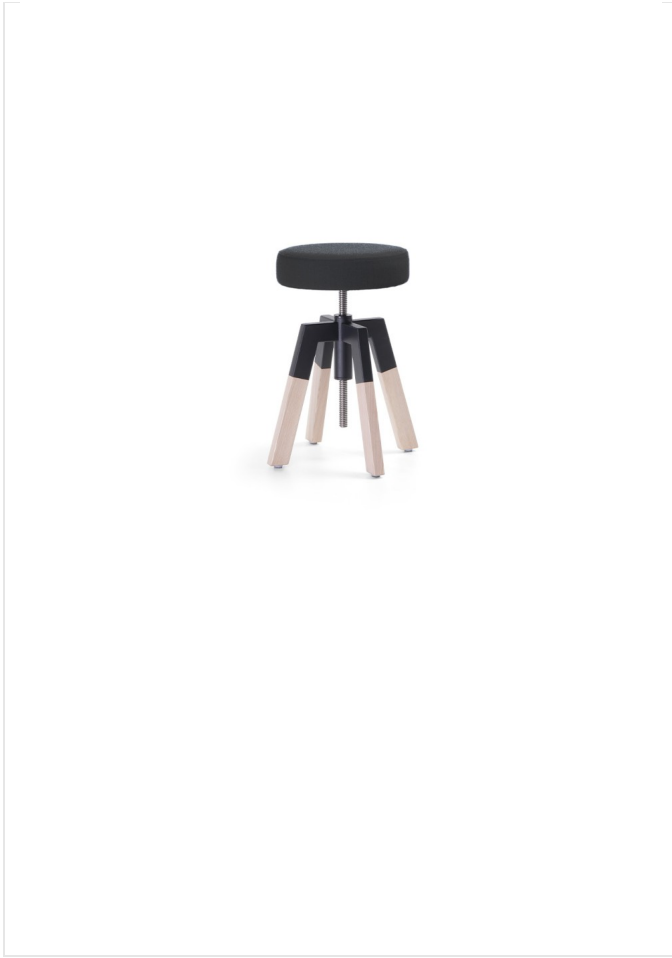

## spin SN W TH

### Seduces with simplicity

We want to be seduced by simplicity, but at the same time we want objects that surround us to be deeply thought out and technologically advanced. The answer to this is the practical and thrilling Spin collection.

### The most important is the detail

Spin is the proof that everything revolves around a well-designed detail. A detail that not only makes the product visually unique, but also raises comfort to a higher level.

## SN W TH / Technical data

● Standard

○ Option

### Base

Legs: solid oak wood - natural color (O1) + powder coated metal construction (colors according to the Bejot sampler) ●

Legs: solid wood - black coloring (O3) + powder coated metal construction (colors according to the Bejot sampler) ○

Height adjustment screw ●

### Feet

#### CODE

Felt feet on wooden floors and panels ●

WF

Feet on ceramic, concrete and carpet floors ○

WK

### Stitches

#### CODE

Stitches in the colour of upholstery. ●

White, grey, orange, red, green or black stitches. ○

## SN W TH / Dimensions

Dimensions are approximate and may vary depending on the selected product configuration. The requirements of the standard are always met.

seat height: overall dimensions	A
seat height: measured according to the norm PN EN 1335 - 1	B
chair height	C
backrest height	D
headrest height	E
dimensional width chair / ø base	F
seat width	G
backrest width	H
width between armrests	I
height from the floor to the armrest	K
backrest length	L
dimensional chair depth	M
seat depth / seat length	N

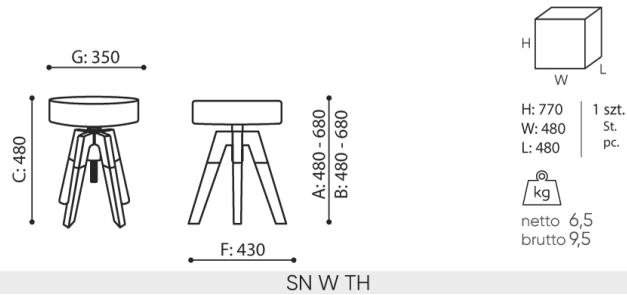

## spin SNR TH

### Seduces with simplicity

We want to be seduced by simplicity, but at the same time we want objects that surround us to be deeply thought out and technologically advanced. The answer to this is the practical and thrilling Spin collection.

### The most important is the detail

Spin is the proof that everything revolves around a well-designed detail. A detail that not only makes the product visually unique, but also raises comfort to a higher level.



## SNR TH / Technical data

Standard

Option

### Base

Powder painted (colors according to the Bejot sampler book)

Height adjustment screw

### Feet

CODE

Spherical feet

### Stitches

CODE

Stitches in the colour of upholstery.

White, grey, orange, red, green or black stitches.

## SNR TH / Dimensions

Dimensions are approximate and may vary depending on the selected product configuration. The requirements of the standard are always met.

seat height: overall dimensions	A
seat height: measured according to the norm PN EN 1335 - 1	B
chair height	C
backrest height	D
headrest height	E
dimensional width chair / ø base	F
seat width	G
backrest width	H
width between armrests	I
height from the floor to the armrest	K
backrest length	L
dimensional chair depth	M
seat depth / seat length	N

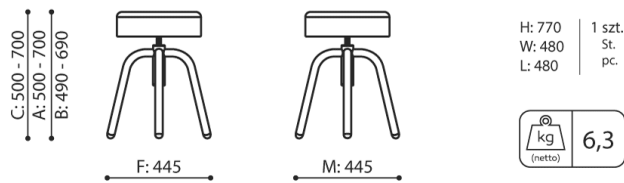

SNR TH