

volò

VO 23C

: product card



The word "Volo" in Italian means "I fly," and symbolizes the **lightness, mobility, and freedom** that define the collection. Inspired by minimalist design, Volo combines elegance, durability, and efficiency. Every detail is thoughtfully crafted to optimize materials and reduce waste – without compromising strength or structure.

With its lightweight construction, stackable design, and the ability to connect in rows, the Volo collection is ideal for conference rooms, auditoriums, public spaces, and any environment that requires quick rearrangement. The range also includes benches available in 2-, 3-, 4-, and 5-seater versions, with or without an integrated tabletop.

design:

Scagnellato & Ferrarese

Product website
[website link](#)



bejot:

collection advantages

Lightness. Freedom. Mobility.

The word "Volo" comes from Italian and means "**I fly**". It evokes the idea of flight – a symbol of lightness, movement, and freedom. These qualities are reflected in the chair's design: a slender frame and perfectly balanced proportions create a sense of visual lightness that harmonizes with any space. Thoughtfully designed, Volo maintains subtle elegance while delivering full functionality.

versatile colours to match every space

Volo chairs come in five vibrant colour combinations that energize the space and emphasize its character. With a choice of upholstered or plastic finishes, the collection adapts effortlessly to both minimalist interiors and bold, expressive spaces. As a result, Volo is not just a functional seating solution but also a decorative element that draws the eye and enhances the overall style of any environment.

freedom of choice

Volo offers true freedom of configuration, allowing you to create a chair perfectly suited to your needs and the style of your space. Choose from **six base options**, including castors, sled base, or classic four legs, and customize your Volo chair to fit any environment – whether for

conference rooms, auditoriums, or public spaces.

technical data

VO 23C

Standard ●
Option ○

Base

Powder coated (color: NCS 4000-N, NCS 8005-Y20R, NCS S 6010-G10Y, NCS S 8005-R50B, RAL 9005S) ●

Chrome plated (chairs only, option not available for VO TR wheelchair) ○

Backrest for 2M version

Black mesh CLASSIC ●

CLASSIC light grey mesh ○

Additional adjustment

VO 231 - Chair connector, mounted to the seat, allowing for row numbering ○

VO 230/ 23C - Chair connector, seat-mounted, allowing row numbering ○

Glides

Glides for ceramic floors, concrete floors and carpets ●

Felt glides for wood floors and panels ○



Stacking

VO 231 1N 6 pcs.

VO 231 2N, 3N, 2M 4 pcs.

VO 230 1N 6 pcs.

VO 230 2N, 3N, 2M 4 pcs.

VO 23C 1N 6 pcs.

VO 230 2N, 3N, 2M 4 pcs.

Trolley

trolley for chairs VO 231/230

VO TR



Stacking

VO 231 1N 6 pcs.

VO 231 2N, 3N, 2M 4 pcs.

























VO 230 1N 6 pcs.

VO 230 2N, 3N, 2M 4 pcs.

VO 23C 1N 6 pcs.

VO 230 2N, 3N, 2M 4 pcs.

Available color combinations of plastics and metal frame in Volo chairs

Color code	Plastic colors		Available metal frame colors			
	armrest, connectors and seat cover	seat and backrest				
VO WGH	 NCS 4000-N	+	 NCS 1000-N	 4000N (NCS 4000-N)	 RAL 9005 S	 chrome*
VO GCM	 NCS 8005-Y20R	+	 NCS S 6005-Y20R	 85Y2R (NCS 8005-Y20R)	 RAL 9005 S	 chrome*
VO TG	 NCS S 6010-G10Y	+	 NCS S 3005-G50Y	 61G1Y (NCS S 6010-G10Y)	 RAL 9005 S	 chrome*
VO BLB	 NCS S 8005-R50B	+	 NCS S 6010-R90B	 RAL 5008 S	 RAL 9005 S	 chrome*
VO NN	 NCS 9000 N	+	 NCS 9000 N		 RAL 9005 S	 chrome*

* option at an additional cost

dimensions

VO 23C

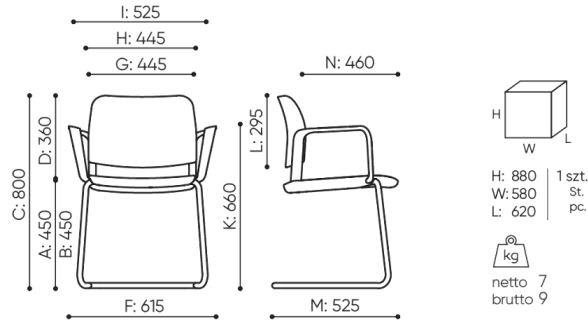

H: 880 1 szt.
W: 580 St.
L: 620 pc.

kg
netto 7
brutto 9

VO 23C 1N

B seat height: measured according to the norm PN EN 1335-1 with a load of 640N

C chair height adjustment

D backrest height adjustment

F dimensional width chair / base

G seat width

H backrest width

K height from the floor to the armrest

L backrest length

M dimensional chair depth

N seat depth adjustment / seat length

All dimensions are in [mm] and refer to basic version products. The indicated dimensions can change depending on the selected equipment package. Bejot reserves the right to change selected elements and this may slightly affect the product's dimensions. In case of any special requirements on dimensions of a given product, the afore-mentioned information should be acknowledged by the Producer. The specification does not constitute an offer within the meaning of the Civil Code. Dimensions and weights are approximate and may vary by 5%. The requirements of the standard are always met.

materials available for collection

1st price group	Bond, Fenno, Keimo, Lodge, Sawana
2nd price group	Alaska, Alpa, Charles, Charles - Studio Design, Cura, Era - Studio Design, Pastel, Roccia, Valencia
3rd price group	Ally, Ally-Studio Design, Alpa-Studio Design, Blazer, Cura - Studio Design, Cyber-Studio Design, Easy - Studio Design, Oceanic, Silvertex, Silvertex - Studio Design, Synergy, Synergy - Studio Design, Valencia - Studio Design
4th price group	Oceanic-Studio Design, Remix - Studio Design
5th price group	Steelcut Trio 3-Studio Design
Leather	Leather
Membrane	Membrane Kyos, Momo, Milla
Plastic	Plastik Volo

bejot:volo

